

80mm

240mm

105mm

IP Speaker



V1.0W 20220831

*Please read this manual carefully before installation for proper operation and maintenance

Contents

I. Product Description	1
1. Product Appearance	1
2. Packing List	1
II. Panel Introduction	2
1. Front Panel	2
2. Rear Panel	2
III. Installation Method	3
1. Installation Position	3
2. Wiring Method	4
IV. Instruction	5
1. Website Login	5
2. Basic Information of Device	5
3. Program Management	6
4. Network Settings	7
5. Firmware Upgrade	7
6. Technical Parameters	7
V. FAQ & Solutions	9

IV. Instruction

1. Website Login

The device can be accessed through a web browser on the LAN. Enter the IP address of the device in the address box. The default IP address of the terminal is 192.168.1.108 and press Enter to confirm. Enter the default user name (admin) and password (admin), and click Login to query or modify device parameters:

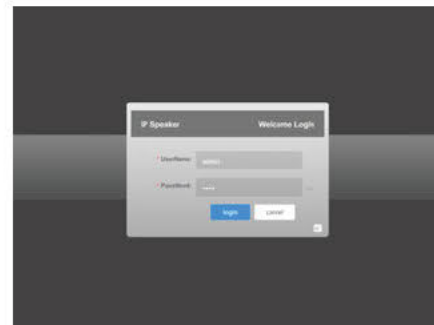

2. Basic Information of Device

The user can view information such as the device ID, name, model, IP address, default gateway, subnet mask, and MAC address on the basic information page.

I. Product Description

1. Product Appearance



- Integrated design brings network audio decoding, digital amplifier, and the horn speaker together;
- Built in HiFi and stereo digital power amplifier;
- Support network remote control and monitoring of the horn speaker working state, allowing more convenient O&M;
- Remote volume adjustment through a service software;
- Accessible at positions with an Ethernet port. Support cross network segments and cross routing.

2. Packing List

Name	Quantity	Unit
Manual	1	Copy
Laws and regulations manual	1	Copy
IP Speaker	1	PCS
Network waterproof sleeve	1	Set

II. Panel Introduction

1. Front Panel



- ① Earthing point
- ③ DC = 24V interference
- ⑤ Trumpet

2. Rear Panel



- ② Pickup microphone interference
- ④ Network interface
- ⑥ Handle

III. Installation Method

1. Installation Position

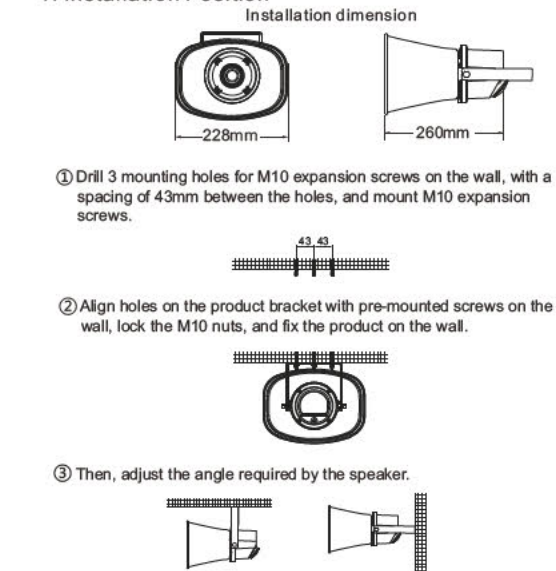

2. Wiring Method

① Power supply wiring diagram of POE

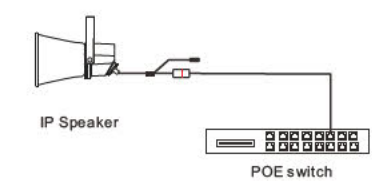

② Power supply wiring diagram of DC24V adapter

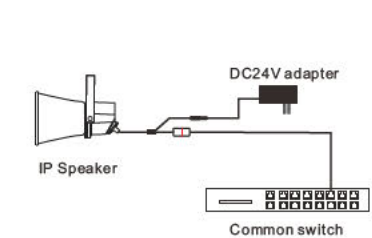

Intellective Control Public Address System

Warning

Please do not open the casing cover by yourself to avoid electric shock. In case of device failure, contact an agent or the manufacturer for maintenance services, or entrust a professional with a professional certificate of a professional department to repair device. Non-professional personnel should not disassemble the device to avoid electric shock accidents and to protect the life safety of operators. This product is only suitable for safe use in non-tropical climate!

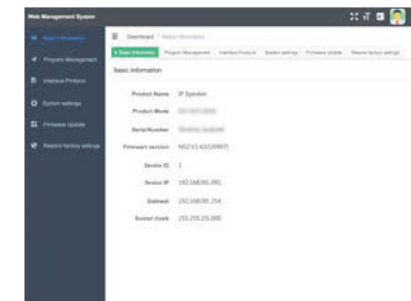

3. Program Management

The user can view, delete and upload MP3 files to the storage space of the device, and click to start/stop playing the uploaded MP3 files on the program management page;

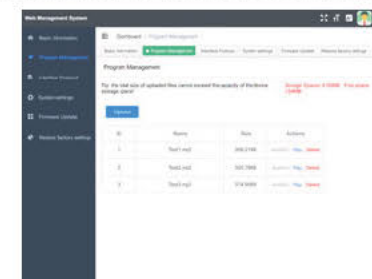

4. Network Settings

On the System Settings, Interface Management, and Restore Factory Settings pages, the user can modify device parameters, such as ID, name, model, IP address, default gateway, and subnet mask, or one-click restore factory settings to reset all parameters:

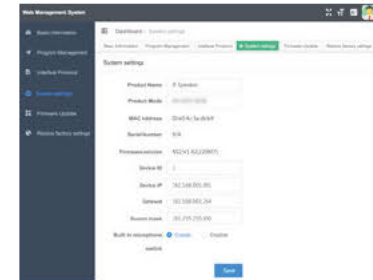

5. Firmware Upgrade

The user can perform a functional upgrade of the firmware of the device on the firmware upgrade page.

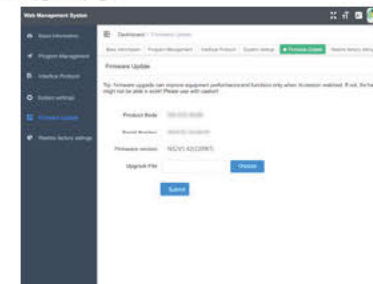

6. Technical Parameters

Power Supply	DC24V/POE power supply
Network Interface	RJ45
Network Communication Protocol	TCP UDP ARP ICMP IGMP SIP ONVIF
Power (W)	20
Sensitivity (dB)	102
Frequency Response (Hz)	250-16K
Horn Speaker Dimension (mm)	225*170*250
Packing Dimension (mm)	240*200*285
Gross Weight (Kg/PCS)	2.5

V. FAQ & Solutions

Sometimes the anomaly is caused by the influence of other device. Please carefully read the instruction manual of all the device before operation. Incorrect operation will often cause the anomaly. In case of any anomaly, please troubleshoot it by referring to the following methods.

FAQ	Cause	Solutions
No sound of the horn speaker	The task is not executed or muted	Check whether the terminal is online and whether the volume of the software is turned up
The terminal is not online	No networking	Check whether the switch runs normally, whether the network cable and network interface are faulty, whether it is on the same LAN as other devices, and whether the terminal IP address is correctly configured

Note: If troubleshooting is still not feasible, please send the device to the nearby dealer for maintenance.

Announcement:
This manual provides customers with guidance and reference, so that customers can use the products correctly and safely. In case of any change in technology or material, the Company shall reserve the right to interpret without notice. Thanks a lot for your understanding.